

This manual applies to photovoltaic modules (“PV modules” , also commonly known as solar panels) manufactured by Yingli Energy Development Company Limited (“Yingli Solar”), and is explicitly written for qualified professionals (“Installer” or “Installers”), including without limitation licensed electricians and RAL Certified PV Installers.

INTRODUCTION

Thank you for choosing Yingli Solar as your PV module provider. We appreciate your business! This manual contains important information pertaining to the electrical and mechanical installation and maintenance of PV modules, and contains safety information that you must read carefully and be familiar with before handling, installing, and/or maintaining Yingli Solar PV modules.

Yingli Solar does not assume responsibility and expressly disclaims liability for losses, damages, or expenses arising out of, or in any way connected with this Installation and User Manual. Yingli Solar assumes no responsibility for any infringement of patents or other rights of third parties, which may result from using Yingli Solar PV modules. No license is granted expressly or by implication or under any patent or patent rights. The information in this manual is believed to be reliable, but does not constitute an expressed or implied warranty. Yingli Solar reserves the right to make changes to its PV modules and other products, their specifications, or this manual without prior notice.

Yingli Solar and its subsidiaries are not liable for any damages caused by inappropriate installation, use, or maintenance of Yingli Solar PV modules, including without limitation damages, losses, and expenses caused by non-observance of the instructions of this manual or caused by or in connection with products of other manufacturers.

Yingli Solar PV modules are designed to meet the requirements for the standards IEC 61215 and IEC 61730, application class A. Modules rated for use in this application class may be used in systems operating at greater than 50 V DC or 240 W, where general contact access is anticipated. Modules qualified for safety through IEC 61730-1 and IEC 61730-2 and within this application class are considered to meet the requirements for safety class II. In the course of the PV module certification process, the compliance of this manual with the certification requirements has been verified by an independent certification laboratory.

This Installation and User Manual is available in different languages. In cases of discrepancy between versions, the English language version shall control.

Failure to comply with the requirements listed in this manual will invalidate the Limited Warranty for PV Modules as provided by Yingli Solar at the time of sale to the direct customer. Additional recommendations are provided to enhance safety practices and performance results. Please provide a copy of this manual to the PV system owner for their reference, and inform them of all relevant aspects of safety, operation and maintenance.

SAFETY

General

You must understand and follow all applicable local, state, and federal regulations and standards for building construction, electrical design, fire, and safety, and must check with local authorities to determine applicable permitting requirements before attempting to install or maintain PV modules.

Rooftop PV systems should only be installed on dwellings that have been formally analyzed for structural integrity, and confirmed to be capable of handling the additional weighted load of PV system components, including PV modules, by a certified building specialist or engineer.



For your safety, do not attempt to work on a rooftop until safety precautions have been identified and taken, including without limitation fall protection measures, ladders or stairways, and personal protective equipment (PPE).

For your safety, do not install or handle PV modules under adverse conditions, including without limitation strong or gusty winds, and wet or frosted roof surfaces.

The flat-plate PV module construction consists of a laminated assembly of solar cells encapsulated within an insulating material with a rigid glass surface and an insulated substrate. The laminated assembly is supported by an aluminum frame that is also used for installation the module. See Figure 1 for an illustration of the PV module components.

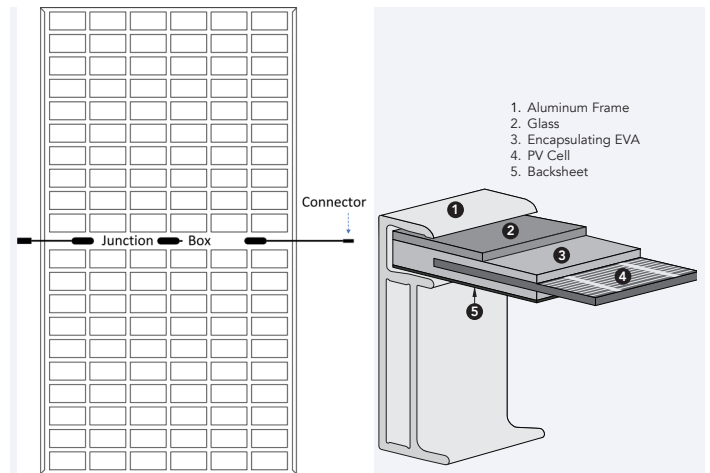

Figure 1: Module components and cross-section of the laminated assembly

Electrical



PV modules can produce current and voltage when exposed to light of any intensity. Electrical current increases with higher light intensity. DC voltage of 30 Volts or higher is potentially lethal. Contacting the live circuitry of a PV system operating under light can result in lethal electric shock.

De-energize PV modules by removing them entirely from light or by covering their front surface with an opaque material. Regard the safety regulations for live electrical equipment when working with modules that are exposed to any light. Use insulated tools and do not wear metallic jewelry while working with PV modules.

In order to avoid arcing and electrical shock, do not disconnect electrical connections under load. Faulty connections can also result in arcing and electrical shock. Keep connectors dry and clean, and ensure that they are in proper working condition. Never insert metallic objects into the connectors, or modify them in any way in order to secure an electrical connection.

Do not touch or handle PV modules with broken glass, separated frames or a damaged backsheet unless the PV modules are first disconnected and you are wearing proper PPE. Avoid handling PV modules when they are wet unless cleaning the PV modules as directed in this manual. Never touch electrical connections that are wet without protecting yourself with insulated gloves.

Transport and Handling

Yingli Solar PV modules must be transported in the supplied packaging only and kept in the packaging until they are ready to be installed. Protect pallets against movement and exposure to damage during transportation. Secure pallets from falling over. Do not exceed the maximum height of pallets to be stacked, as indicated on the pallet packaging. Store pallets in a cool and dry location until the PV modules are ready to be unpackaged.

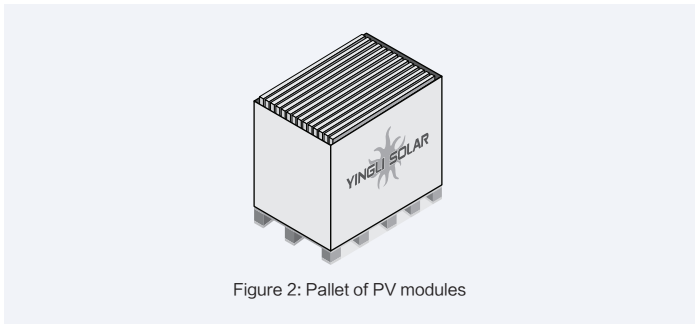

Figure 2: Pallet of PV modules

Yingli Solar PV modules are heavy, and should be handled with care. PV modules shall be handled at the frame; never use the junction box or cables as a grip. Do not exert mechanical stress on the cables. Never step on PV modules or drop or place heavy objects on them. Be careful when placing PV modules on hard surfaces, and secure them from falling. Broken glass can result in personal injury. PV modules with broken glass cannot be repaired and must not be used. Broken or damaged PV modules must be handled carefully and disposed of properly.

For unpacking PV modules from the Yingli Solar supplied packaging, first remove the pallet lid (after removing securing straps, if provided). Remove PV modules one at a time by sliding them up the channel in the package (see Figure 3). You may need to secure the remaining PV modules in the pallet packaging to prevent them from falling over.

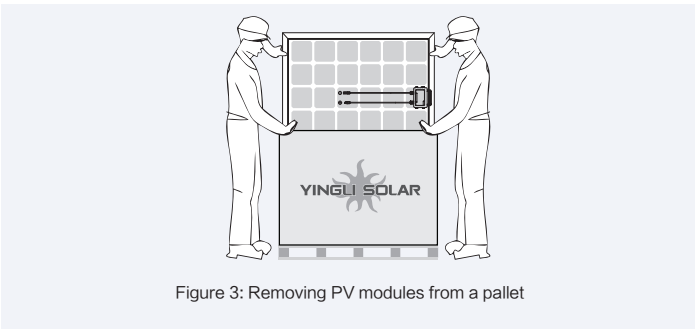

Figure 3: Removing PV modules from a pallet

Check PV modules for damage due to transportation before they are installed; do not install damaged modules. Contact the company you purchased the Yingli

Solar PV modules from in order to obtain information on making claims for defective PV modules.

PV module surfaces are susceptible to damage that could affect the performance or safety of the PV module; do not damage or scratch the PV module surfaces, and do not apply paint or adhesive to any of the surfaces, including the frame. For your safety, do not disassemble or modify Yingli Solar PV modules in any way. Doing so may degrade performance or cause irreparable damage and will void any applicable warranties.

If it is necessary to store PV modules prior to installation, the PV modules should remain inside the packaging and protected from exposure that could compromise the durability of the packaging.

Fire

Yingli Solar PV Modules have a Class C fire resistance rating in accordance with the IEC 61730-2 certification. When PV modules are mounted on rooftops, the roof must have a fire resistant covering suitable for this application. PV modules are electrical generating devices that may affect the fire safety of a building.

The use of improper installation methods and/or defective parts may result in the unexpected occurrence of an electrical arc during operation. In order to mitigate the risk of fire in this event, PV modules should not be installed near flammable liquids, gases, or locations with hazardous materials.

In the event of a fire, PV modules may continue to produce a dangerous voltage, even if they have been disconnected from the inverter, have been partly or entirely destroyed, or the system wiring has been compromised or destroyed. In the event of fire, inform the fire crew about the particular hazards from the PV system, and stay away from all elements of the PV system during and after a fire until the necessary steps have been taken to make the PV system safe.

APPLICATION INFORMATION

Application Restrictions

Yingli Solar PV modules must be mounted on appropriate installation structures positioned on suitable buildings, the ground, or other structures suitable for PV modules (e.g. carports, building facades or PV trackers). PV modules must not be mounted on moving vehicles of any kind. Yingli Solar PV modules must not be installed in locations where they could be submerged in water.

Yingli Solar PV modules must not be sited in locations where aggressive substances such as salt or salt-water, or any other type of corrosive agent, could affect the safety and/or performance of the PV modules. Although some types of Yingli Solar PV modules have passed the IEC 61701 salt-mist corrosion test with a salt concentration of 5% by weight, galvanic corrosion can occur between the aluminum frame of the PV module and installation or grounding hardware if such hardware is comprised of dissimilar metals. Yingli Solar recommends that only stainless steel and aluminum metal directly contact PV modules in seaside installations to limit corrosion.

Artificially concentrated light must not be directed on Yingli Solar PV modules.

Design Recommendations

Yingli Solar recommends that PV modules be mounted at a minimum tilt angle of 10 degrees to allow for proper self-cleaning from normal rain showers.

Partial or complete shading of a PV module or modules can significantly reduce system performance. Yingli Solar recommends minimizing the amount of shade throughout the year to increase the amount of energy produced by the PV modules.

Lightning protection is recommended for PV systems that are to be installed in locations with high probability of lightning strikes.

High system voltages could be induced in the event of an indirect lightning strike, which could cause damage to PV system components. The open area of wire loops should be minimized, as shown in Figure 4, in order to reduce the risk of

lightning induced voltage surges.

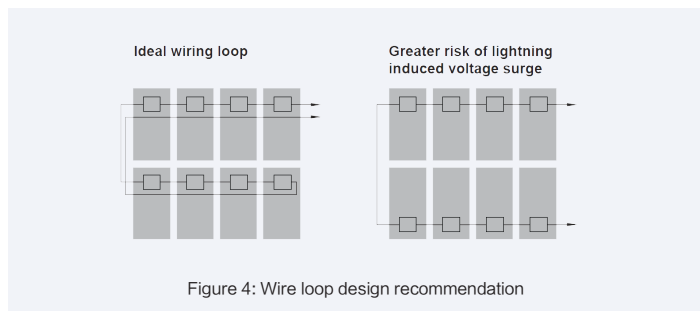

Figure 4: Wire loop design recommendation

ELECTRICAL INSTALLATION

Electrical Configuration

Under normal conditions, a photovoltaic module is likely to experience conditions that produce more current and/or voltage than reported at Standard Test Conditions (STC: 1000 W/m², AM 1.5, and 25°C cell temperature). The short-circuit current (ISC) should be multiplied by a factor of 1.25 and the open-circuit voltage (VOC) should be multiplied by a factor of up to 1.25 based on the lowest ambient temperature recorded for the installation location when determining component voltage ratings, conductor current ratings, fuse sizes, and size of controls connected to the PV output.

Voltages are additive when PV modules are connected directly in series, and module currents are additive when PV modules are connected directly in parallel, as illustrated in Figure 5. PV modules with different electrical characteristics must not be connected directly in series. The use of suitable third-party electronic devices connected to PV modules may enable different electrical connections and must be installed according to the manufacturer's specified instructions.

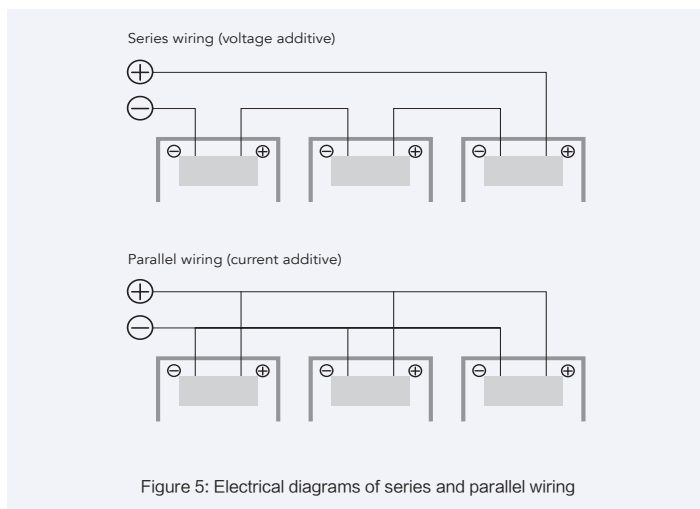

Figure 5: Electrical diagrams of series and parallel wiring

The maximum number of PV modules that can be connected in a series string must be calculated in accordance with applicable regulations in such a way that the specified maximum system voltage of the PV module and all other electrical DC components will not be exceeded in open-circuit operation at the lowest temperature expected at the PV system location.

An appropriately rated overcurrent protection device must be used when the reverse current could exceed the value of the maximum fuse rating of the module. An over current protection device and anti-reflection diode module are required for each series string if more than two series strings are connected in parallel, and reverse polarity is forbidden.

Cables and Wiring

Yingli Solar PV modules are provided with two (2) stranded, sunlight resistant output cables that are terminated with PV connectors ready for most installations. The positive (+) terminal has a female connector while the negative (-) terminal

has a male connector. The module wiring is intended for series connections [i.e. female (+) to male (-) interconnections], but can also be used to connect suitable third-party electrical devices that may have alternative wiring configurations so long as the manufacturer's instructions are followed.

Use field wiring with suitable cross-sectional areas that are approved for use at the maximum short-circuit current of the PV module. Yingli Solar recommends installers use only sunlight resistant cables qualified for direct current (DC) wiring in PV systems. The minimum wire size should be 4mm².

Table 1: Required minimum field wiring specifications

| | Testing Standard | Wire Size | Temperature Rating |
|-------------------------------|------------------|-------------------|--------------------|
| Required Minimum Field Wiring | EN 50618 | 4 mm ² | - 40°C to + 90°C |

Cables should be fixed to the installation structure in such a way that mechanical damage of the cable and/or the module is avoided. Do not apply stress to the cables. Do not bend cables to a bending radius of less than 40mm. For fixing, use appropriate means, such as sunlight resistant cable ties and/or wire management clips specifically designed to attach to the PV module frame. While the cables are sunlight resistant and waterproof, where possible, avoid direct sunlight exposure and water immersion of the cables.

Connectors



Keep connectors dry and clean, and ensure that connector caps are hand tight before connecting the modules. Do not attempt making an electrical connection with wet, soiled, or otherwise faulty connectors. Avoid sunlight exposure and water immersion of the connectors. Avoid connectors resting on the ground or roof surface.

Faulty connections can result in arcs and electrical shock. Check that all electrical connections are securely fastened. Make sure that all locking connectors are fully engaged and locked.

Modules must not be interconnected using connectors from different manufacturers and / or of different types. If modules having such different connectors need to be interconnected, a qualified professional may replace connectors according to the manufacturers' specified instructions such that an interconnection can be made with connectors from the same manufacturer and the same type.

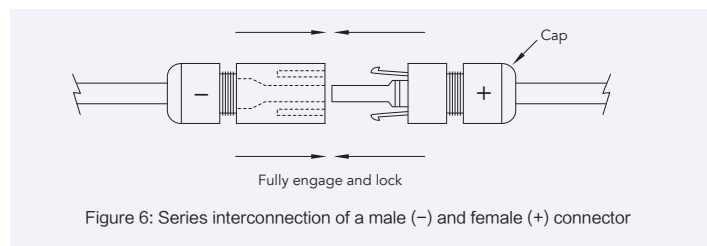

Figure 6: Series interconnection of a male (-) and female (+) connector

Bypass Diodes

The junction boxes used with Yingli Solar PV modules (not Smart Hot Spot Free module) contain bypass diodes wired in parallel with the PV cell strings. In the case of partial shading, the diodes bypass the current generated by the non-shaded cells, thereby limiting module heating and performance losses. Bypass diodes are not overcurrent protection devices.

Bypass diodes divert current from the cell strings in the event of partial shading. See Figure 7-1 for a diagram showing how the cell strings are electrically connected with the diodes.

Every piece of cells from Yingli Smart Hot Spot Free module parallels a diode, with a cell is covered by shade or occurs an exception, the paralleled diode can bypass this cell, thus avoid hot spot, and can retain the maximum power output.

Bypass diodes divert current from a cell in the event of partial shading, See figure 7-2 for a diagram showing how the cells are electrically connected with the diodes.

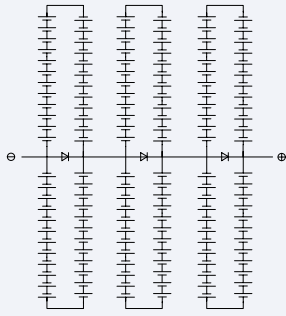

Figure 7-1: Electrical circuitry of cell strings and bypass diodes

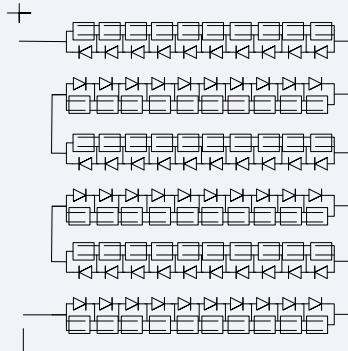

Figure 7-2: Electrical circuitry of cells and bypass diodes

In the event of a known or suspected diode failure, installers or maintenance providers should contact the company the PV modules were purchased from. Never attempt to open the junction box of a Yingli Solar PV module yourself.

PV Array Grounding

For optimal performance, Yingli Solar recommends that the negative pole of the PV array be connected to ground.

Equipment Grounding

The frame of the PV module, as well as any exposed non-current-carrying metal parts of fixed equipment that are able to become energized by the PV system, must be connected to the equipment grounding conductor (EGC) in order to prevent electrical shock. Even when applicable regulations, code requirements, and standards do not require safety-related grounding, Yingli Solar recommends grounding all PV module frames in order to ensure the voltage between electrically conductive equipment and earth ground is zero in all circumstances.

Proper equipment grounding is achieved by bonding all exposed non-current-carrying metal equipment continuously to one another using an appropriately sized EGC or racking system that can be used for integrated grounding (see Option B in Grounding Methods below).

Yingli Solar PV modules employ a coated aluminum frame for corrosion resistance. In order to properly ground the module frame, the coating must be penetrated.

The potential for corrosion due to the electrochemical action between dissimilar metals in contact is minimized if the electrochemical voltage potential between the dissimilar metals is low. The grounding method must not result in the direct contact of dissimilar metals with the aluminum frame of the PV module that will result in galvanic corrosion. An addendum to UL Standard 1703 "Flat Plate Photovoltaic Modules and Panels" recommends metal combinations not exceed an electrochemical potential difference of 0.5 Volts.

The frame rails have pre-drilled holes marked with a grounding sign, as illustrated in Figure 8. These holes should be used for grounding purposes and must not be used for installation the PV modules. Do not drill additional holes into the frame rails.

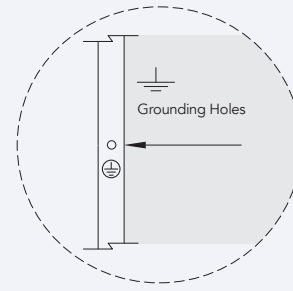

Figure 8: Grounding hole detail

The following grounding methods are available:

Option A: Screw Assembly (see Figure 9)

1. The grounding screw must be installed on the designed grounding hole and must be stainless steel screw.
2. The screw first passes through the stainless steel flat washers. The screw rods pass through the grounding holes outwards, and then pass through the stainless steel piercing washers, grounding terminal, stainless steel flat washers, and stainless steel spring washers in turn, and finally fix them with stainless steel backing nuts.
3. Tighten the backing nut to a torque of not less than 4 N·m to ensure that the backing nut can securely hold the screw.
4. Install piercing washers of appropriate size, and ensure that the protrusions of the piercing washers reliably pierce the frame of the module.

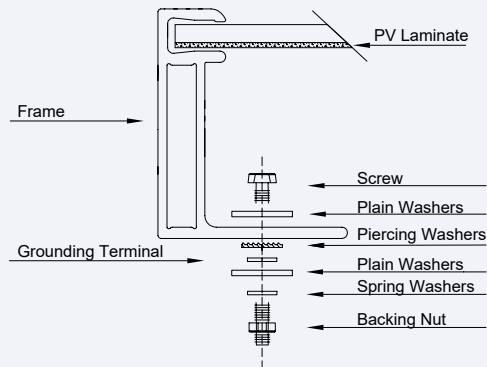

Figure 9: Grounding screw assembly detail

Option B: Racking Manufacturer Integrated Grounding Methods

Yingli Solar PV modules can be grounded by bonding PV modules to a grounded racking system. Integrated grounding methods must be certified for grounding PV modules and must be installed in accordance with the specified instructions of their respective manufacturers.

Option C: Additional Third-party Grounding Devices

Yingli Solar PV modules can be grounded using third party grounding devices so long as they are certified for grounding PV modules and the devices are installed according to the manufacturer's specified instructions.

MECHANICAL INSTALLATION

General

Yingli Solar PV Modules have been certified for a maximum static load on the back of the module of up to 2400 Pa (i.e. wind load) and a maximum static load on the front of the module of up to either 2400 Pa or 5400 Pa (i.e. wind and

snow load), depending on the module type (please refer to the data sheet for this information).

Installation structures and other mechanical parts must be designed and approved to withstand the design wind and snow loads applicable for a particular site. Yingli Solar PV modules must not be subjected to forces from the substructure, including forces caused by thermal expansion.

The installation method must not result in the direct contact of dissimilar metals with the aluminum frame of the PV module that will result in galvanic corrosion. An addendum to UL Standard 1703 “Flat Plate Photovoltaic Modules and Panels” recommends metal combinations not exceed an electrochemical potential difference of 0.5 Volts. Yingli Solar PV modules can be mounted in landscape or portrait orientation, as illustrated in Figure 10, provided that the installation method follows one of the acceptable methods listed below.

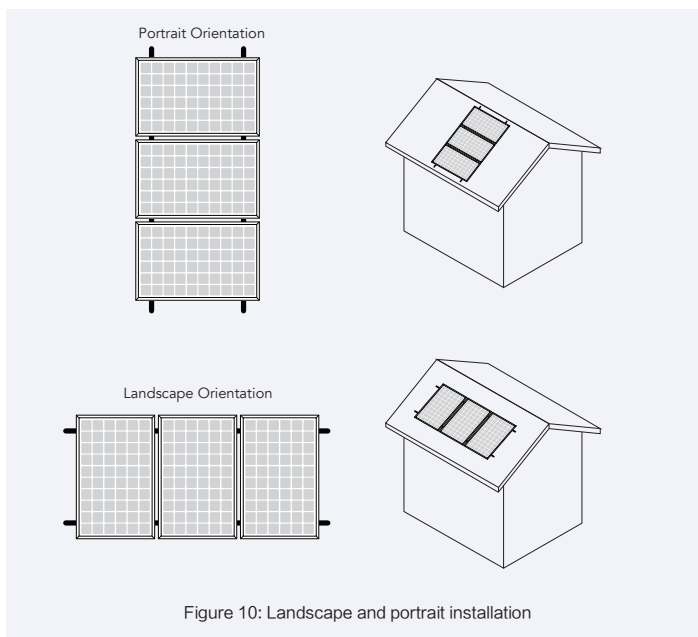

Figure 10: Landscape and portrait installation

In order to maintain the fire class rating, the distance between the PV module front surface (glass) and the roof surface shall be at least 10 cm. This spacing also allows air flow to cool the PV module. Install PV modules with a minimum spacing of 1 cm between neighboring frames to allow for thermal expansion.

Installation Methods

The following installation methods are available:

Bolts or Clamps

Refer to figure 12 and 13. Do not modify the existing installation holes or drill new holes. Do not apply excessive pressure on the frame such that the frame deforms.

- **Bolts:** Modules must be mounted using the installation holes located on the rear side of the long frame parts using M8 stainless steel bolts, nuts, and washers. The torque of screw tightening should be between 14 N · m to 20 N · m.

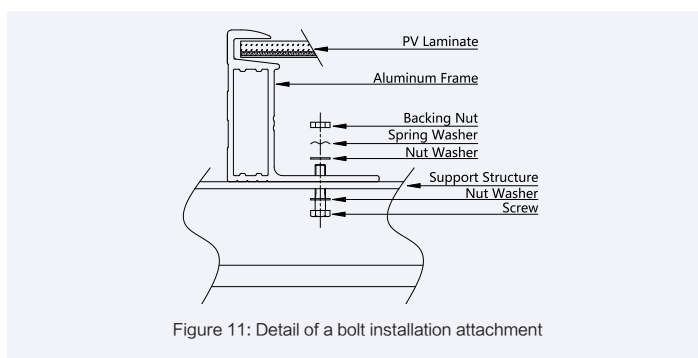

Figure 11: Detail of a bolt installation attachment

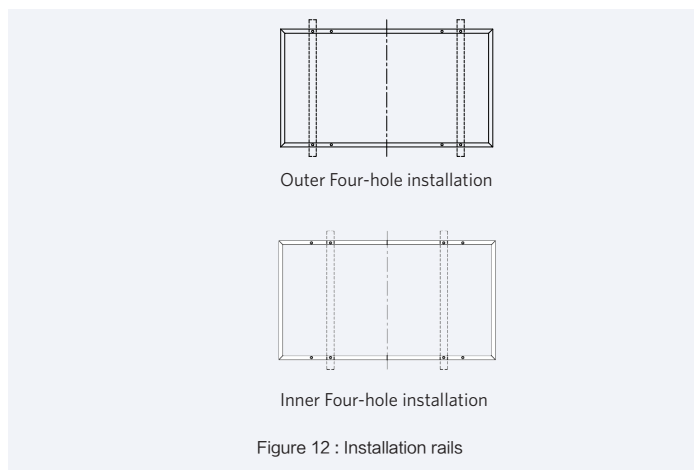

Figure 12 : Installation rails

The large size modules are mounted with four outer holes, with max mechanical loads of 5400 Pa snow (front) and 2400 Pa wind (back).

- **Top-down Clamps:** Third-party clamps that have been designed for PV installation structures are an approved installation attachment method for Yingli Solar PV modules. Modules must be fastened using clamps applied to the top side of the long frame parts. A clamp holds two modules except for the clamps at the beginning and end of a module row. The module clamps should not contact with the front glass and deform the frame, and avoiding shadowing effects from the module clamps. The module frame is not to be modified under any circumstances. The applied torque value should be big enough to fix the modules steadily, the torque of screw tightening should be between 16 N · m to 24 N · m.

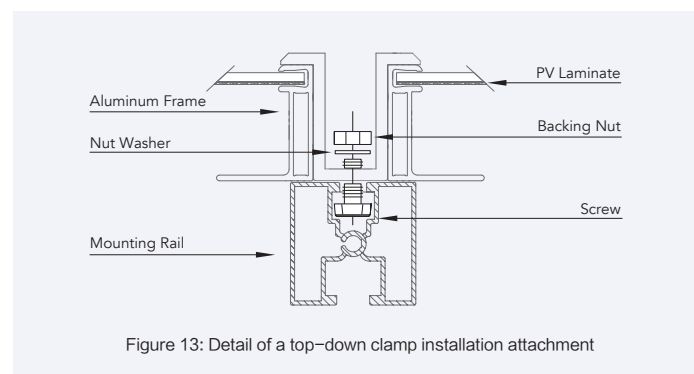

Figure 13: Detail of a top-down clamp installation attachment

MAINTENANCE

General

Yingli Solar recommends that PV systems be periodically inspected by the installer, or other qualified person.

The purpose of the PV system inspection is to ensure that all system components are functioning properly. At a minimum, this inspection should confirm the following:

- All cables and connector attachments are undamaged and properly secured
- No sharp objects are in contact with the PV module surfaces
- PV modules are not shaded by unwanted obstacles and/or foreign material
- Installation and grounding components are tightly secured with no corrosion

Defects should be addressed immediately.

Cleaning

Over time, dirt and dust can accumulate on the glass surface of the module, reducing its power output. Yingli Solar recommends periodic cleaning of PV modules to ensure maximum power output, especially in regions with low precipitation.

In order to reduce the potential for electrical and thermal shock, Yingli Solar recommends cleaning PV modules during early morning or late afternoon hours when solar radiation is low and the modules are cooler, especially in regions with hotter temperatures.

Never attempt to clean a PV module with broken glass or other signs of exposed wiring, as this presents a shock hazard.

Clean the glass surface of the PV modules with a soft brush using soft, clean water (PH6–9) with a recommended pressure less than 690kPa, which is typical of most municipal water systems. Water with high mineral content may leave deposits on the glass surface and is not recommended.

Yingli Solar PV modules may contain a hydrophobic anti-reflective coating on the glass surface to enhance power output and reduce dirt and dust buildup. In order to avoid module damage, do not clean PV modules with a power washer or pressure washer. Do not use steam or corrosive chemicals to facilitate the cleaning of modules. Do not use aggressive tools or abrasive materials that could scratch or damage the glass surface. Failure to comply with these requirements may adversely affect the PV module performance.

Yingli Solar PV modules are designed to withstand high snow loads. However, if removing snow is desired to enhance production, use a brush to gently remove snow. Do not try to remove frozen snow or ice from PV modules.

DECOMMISSIONING

The dismantling of PV systems must be performed with the same care and safety precautions used during the initial installation. The PV system can generate hazardous voltage even after the system has been disconnected. Follow safety regulations for working with live electrical equipment.

RECYCLING

Yingli Solar is a member of PV Cycle, the European association for voluntary take back and recycling of PV modules. Please contact PV Cycle at www.pvcycle.org for details regarding the recycling process.



Meaning of crossed -out wheeled dustbin:

Do not dispose of electrical appliances as unsorted municipal waste, use separate collection facilities.

Contact your local government for information regarding the collection systems available.

If electrical appliances are disposed of in landfills or dumps, hazardous substances can leak into the groundwater and get into the food chain, damaging your health and well-being.

When replacing old appliances with new ones, the retailer is legally obligated to take back your old appliance for disposals at least free of charge.

Yingli Energy Development Company Limited
service@yingli.com
Service hotline: +86-312-8922216
YLD_IM_PANDA 3.0_GB_EN_V02

Revision date: Dec. 12th, 2022 | Applicable for IEC certified products | The second edition

The information in this supplement is believed to be reliable, but does not constitute an expressed or implied warranty. Yingli Solar reserves the right to make changes to its PV modules and other products, their specifications, or this supplement without prior notice.

This supplement to the installation manual does not contain information about some older module series no longer being manufactured by Yingli Solar. If you require information about such modules, please contact Yingli Solar.

This supplement refers to modules of the following types:

MODULE TYPES

| Family | PANDA 3.0 PRO | | | | | | | | | |
|---------------------|-------------------------------|--|-------------------------------|--|-------------------------------|--|-------------------------------|--|-------------------------------|--|
| Type | YLxxxC-38e 1/2 xxx=405-430 | YLxxxC-38e 1500V 1/2 xxx=405-430 | YLxxxC-42e 1/2 xxx=450-480 | YLxxxC-42e 1500V 1/2 xxx=450-480 | YLxxxC-46e 1/2 xxx=495-525 | YLxxxC-46e 1500V 1/2 xxx=495-525 | YLxxxC-50e 1/2 xxx=540-575 | YLxxxC-50e 1500V 1/2 xxx=540-575 | YLxxxC-55e 1/2 xxx=585-625 | YLxxxC-55e 1500V 1/2 xxx=585-625 |
| Max. system voltage | 1000 V | 1500 V | 1000 V | 1500 V | 1000 V | 1500 V | 1000 V | 1500 V | 1000 V | 1500 V |

ELECTRICAL CHARACTERISTICS

Nameplate ratings are average values. The electrical characteristics are within +/- 10 percent of the indicated values of Isc, Voc, and Pmax under Standard Test Conditions (irradiance of 1000 W/m², AM 1.5 spectrum, and a cell temperature of 25°C). Refer to module datasheets for specific power output tolerances. Please refer to Table 1 to see which power classes actually exist for which module series.

INSTALLATION METHOD

1. Mounting hole installation (fixed bracket)

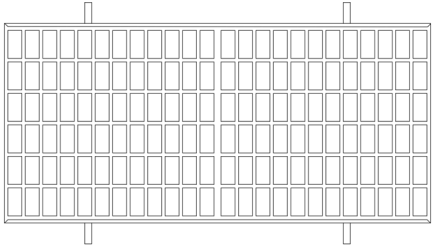
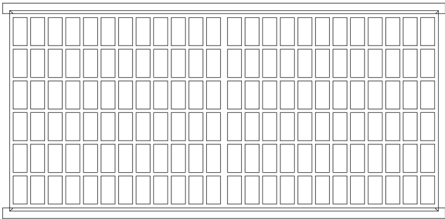
| Type | Mechanical load (Pa) | Safety factor | Schematic diagram |
|---|----------------------|---------------|--|
| Purlin perpendicular to long-side frame | +3600 - 1600 | 1.5 |  |
| Purlin parallel to long-side frame | +1600 - 1600 | 1.5 |  |

Notes:

- To maximize mounting longevity, Yingli Solar strongly recommends the use of corrosion proof (stainless steel) attachment hardware.
- To check whether the surface of the beam is flat and smooth, or add rubber pads on the beam to prevent the module from being crushed when it is pressed down.
- Parts in contact with the modules should use flat stainless steel washers of minimum 1.4 mm thickness with an minimum outer diameter of 15.57 mm.
- Modules can be attached using the mounting holes (2 holes of $\phi 9 \times 14$ mm of one long-side frame, ≥ 1300 mm spacing) on the back of the module frame, by fixing the module to the support rails with bolts.
- Secure the module in each mounting location with M8 bolts and matching flat washers, spring washers and nuts, and tighten to a torque of $14\sim 20$ N · m. The tightening steps as follows: use torque wrench to tighten nut to target torque, nut loosen $90\sim 180$ degrees, finally tighten the nut to the target torque and reduce the torque attenuation.

2. Mounting hole installation (1P tracker)

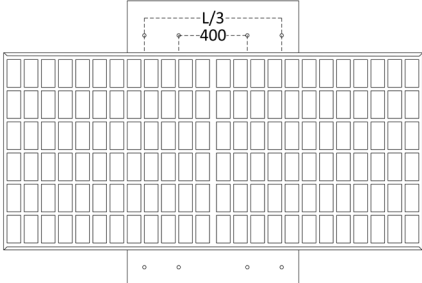
| Type | Mechanical load (Pa) | Safety factor | Schematic diagram |
|------------------------------------|----------------------|---------------|--|
| Purlin parallel to long-side frame | +1600 - 1600 | 1.5 |  |

Notes:

- To maximize mounting longevity, Yingli Solar strongly recommends the use of corrosion proof (stainless steel) attachment hardware.
- Parts in contact with the modules should use flat stainless steel washers of minimum 1.4 mm thickness with an minimum outer diameter of 15.57 mm.
- Modules can be attached using the mounting holes (2 holes of $\phi 7 \times 10$ mm of one long-side frame, 400 mm spacing for special tracker, or 2 holes of $\phi 9 \times 14$ mm of one long-side frame, spacing $\geq L/3$, L represents the length of the long side of the module) on the back of the module frame, by fixing the module to the support rails with bolts.
- Secure the module in each mounting location with 2 M6 bolts or 2 M8 bolts, and matching flat washers, spring washers and nuts, and tighten to a torque of $14\sim 20$ N · m. The tightening steps as follows: use torque wrench to tighten nut to target torque, nut loosen $90\sim 180$ degrees, finally tighten the nut to the target torque and reduce the torque attenuation.

3. Mounting hole installation (2P tracker)

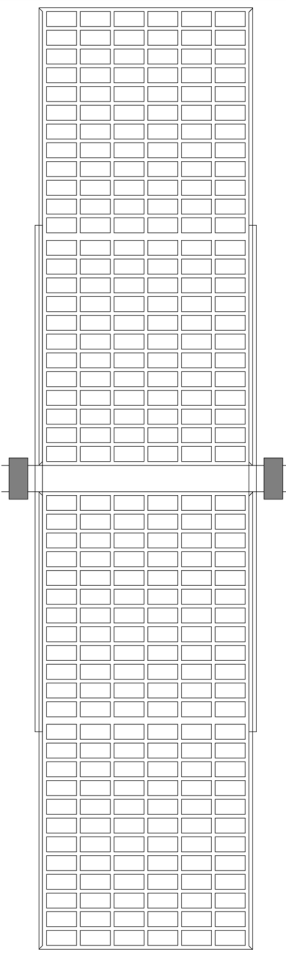
| Type | Mechanical load (Pa) | Safety factor | Schematic diagram |
|------------------------------------|----------------------|---------------|---|
| Purlin parallel to long-side frame | +1600 - 1600 | 1.5 |  |

Notes:

- To maximize mounting longevity, Yingli Solar strongly recommends the use of corrosion proof (stainless steel) attachment hardware.
- Parts in contact with the modules should use flat stainless steel washers of minimum 1.4 mm thickness with an minimum outer diameter of 15.57 mm.
- Modules can be attached using the mounting holes (the number of mounting holes used for a single long-side frame ≥ 2 , including at least one $\phi 7 \times 10$ mm hole) on the back of the module frame, by fixing the module to the support rails with bolts.
- Secure the module in each mounting location with M6 and M8 bolts, and matching flat washers, spring washers and nuts, and tighten to a torque of $14\sim 20 \text{ N} \cdot \text{m}$. The tightening steps as follows: use torque wrench to tighten nut to target torque, nut loosen $90\sim 180$ degrees, finally tighten the nut to the target torque and reduce the torque attenuation.

4. Clamp installation

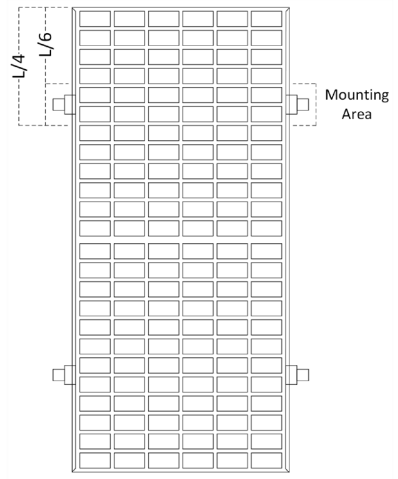
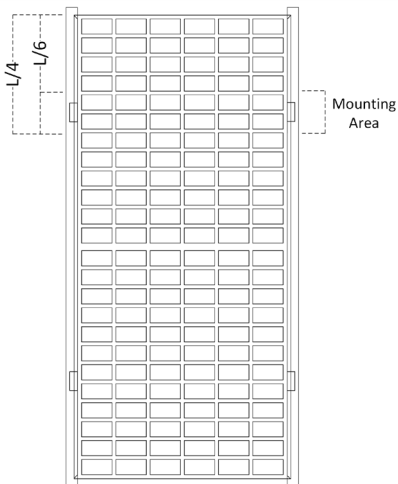
| Type | Mechanical load (Pa) | Safety factor | Schematic diagram |
|---|----------------------|---------------|---|
| Purlin perpendicular to long-side frame | +3600 - 1600 | 1.5 |  |
| Purlin parallel to long-side frame | +1600 - 1600 | 1.5 |  |

Notes:

- To maximize mounting longevity, Yingli Solar strongly recommends the use of corrosion proof (stainless steel) attachment hardware.
- To check whether the surface of the beam is flat and smooth, or add rubber pads on the beam to prevent the module from being crushed when it is pressed down.
- L represents the length of the long side of the module, the described distances are from the module edge to the middle of the clamp.
- The long-side frames of the module are fixed to the mounting beam or rail by at least 4 clamps that can be fitted with M8 bolts.
- The length of the clamp ≥ 40 mm, and the module frame to maintain at least 7 mm but not more than 10 mm overlap part, could not contact with the front glass, shall not make the frame deformation, and should avoid the shading effect of the clamp.
- Tighten M8 bolts to a torque of $14\sim 20$ N · m. The tightening steps as follows: use torque wrench to tighten nut to target torque, nut loosen $90\sim 180$ degrees, finally tighten the nut to the target torque and reduce the torque attenuation.

TRANSFER REQUIREMENTS

It is strictly forbidden for people to stand on both sides of the forklift during the operation, and there is a risk of the box falling over and causing injury to people if the operation speed is too fast, and the stacking of boxes is strictly forbidden.

When lifting, need to use lifting tools with sufficient tension to ensure that the center of gravity of the box is stable and to make suitable support structures on the top of the package, such as wooden boards with the same length and width as the package, to ensure that the top of the modules is not squeezed.

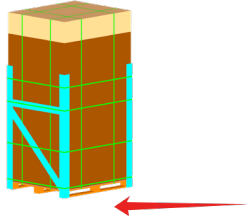

1. Forks enter in the direction of the long side of the pallet, close to the pallet and prohibit slamming against the modules.

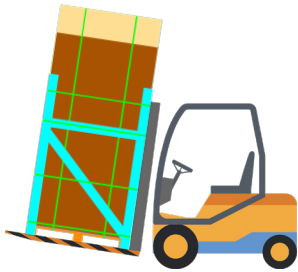

2. Safety ropes are required to secure the modules to the forklift with a tensile strength greater than 2000 kgf.

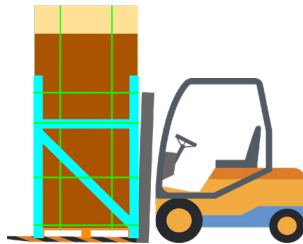

3. When placing it, need to wait for the packing box to be stable before untying the safety rope.

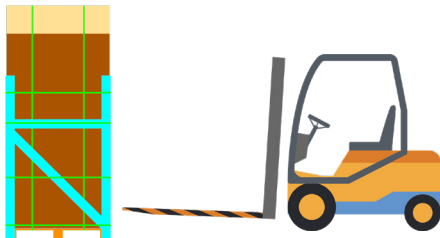

4. Make sure the pallet is separated from the forks and then exit slowly.

Notes:

- Fork length needs to be more than 1.1 m, gantry height needs to be more than 1.7 m and width more than 1.5 m, gantry can withstand more than 1.5 tons pressure.
- The top of the gantry needs to be placed with cushioning material.
- These transfer requirements apply to upright packaging modules.

UNPACKING INSTRUCTIONS

Before unpacking, please check whether the product serial number and information on the external box are correct, read the unpacking instructions carefully, prohibit the use of customized unpacking methods, prohibit violent removal to avoid scratching the modules, please refer to the recommended unpacking steps and tools. Unpacking work must be operated by 2 or more people, wear cut-proof insulated gloves, and other labor protection requirements of PV plant construction specifications need to be met.

Unpacking must be done with anti-tilting brackets, please contact your customer manager for the specific requirements of the anti-tilting bracket.

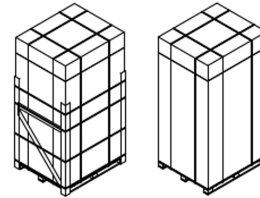

1. Place the package on the flat working ground, cut the packing belts and remove the wooden brackets.

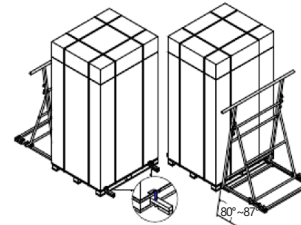

2. Pass the forearm of the anti-tilting bracket through the pallet, insert the two bolts into the front round hole of the anti-tilting bracket, and adjust the support angle of the anti-tilting bracket so that the angle with the ground is between 80° and 87°.

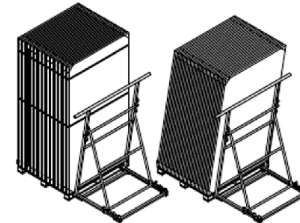

3. Remove the packing belts and carton (the cardboard on one side of the anti-tilting bracket can be retained), leaving only 1 or 2 internal belts, then carefully push the modules so that they rest diagonally against the anti-tilting bracket.

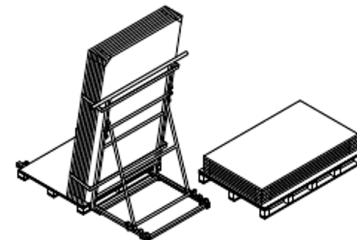

4. Two people work together to carry the modules one by one, if there are any left over, secure the remaining modules to the anti-tilting bracket with tie-downs or place them flat on a pallet (no more than 20 pieces per pallet).

Note:

- These unpacking instructions apply to upright packaging modules.